



Input

Rated input voltage	100 V- 240 V ac
Input voltage range	90 V to 264 V ac
Rated frequency	50-60 Hz
Frequency range	47-63 Hz
Rated input current	600 mA RMS max.
Inrush current	30A max at 115 / 60 A max. at 230 Vac cool start
Leakage current	0.25 mA

Output

Output voltage	18 Vdc at 1.0A
Output min. current	0A
Line regulation	± 1%
Load regulation	± 5%
Over voltage protection	19.0 to 21.0 Vdc (output shut down)
Short circuit protection	output shut down and auto restart
Ripple voltage	150 mV (p-p) (100-240 Vac input at full load)
Efficiency	Energy Star compliant - level IV

Safety and EMI

HI-POT	input to output	3000 Vac or 4242 Vdc at 10 mA for 1 minute
Insulation resistance	input to output	> 100 M Ohm at 500 Vdc
Safety approvals	UL/cUL, CE, GS	
EMI standard	FCC, meets class B, CE, VCCI-II	
RoHS compliant	yes	

Environmental

Storage temperature	-10°C ~ +70° C
Storage humidity	10~90%
Operating temperature	0°C ~ +40° C
Operating relative humidity	20~80%



CUI INC

Part No: EMS180100-P5P-SZ

Date: 5/29/2007

Description: switching power supply
w/ interchangeable input blades

Unit: mm

Page No: 2 of 6

Label

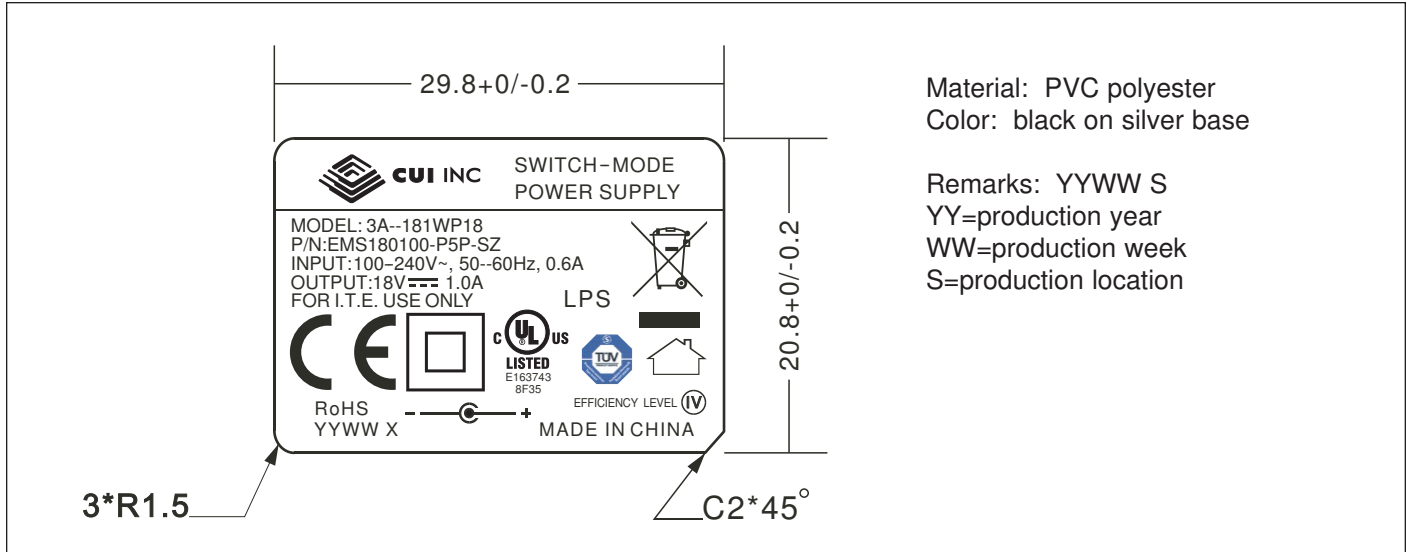



CUI INC

Part No: EMS180100-P5P-SZ

Description: switching power supply
w/ interchangeable input blades

Date: 5/29/2007

Unit: mm

Page No: 3 of 6

Mechanical Drawing

Input plug
Case size

interchangeable input blade
74 L x 43.5 W x 34 H mm

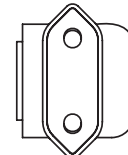
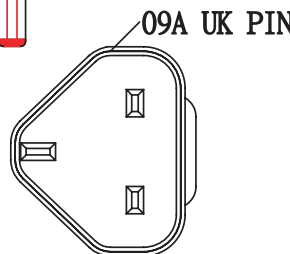
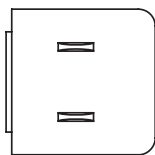
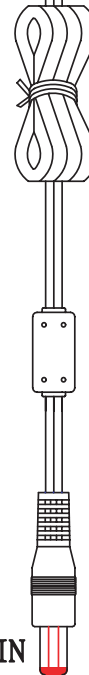
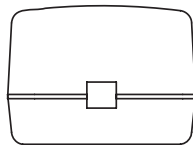
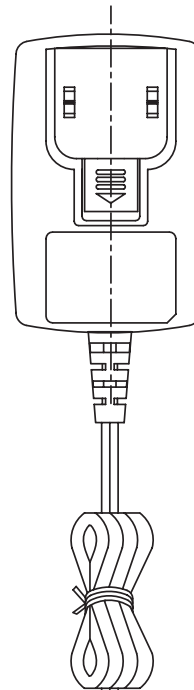
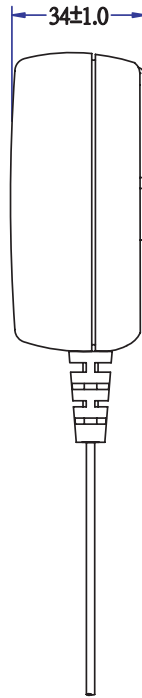
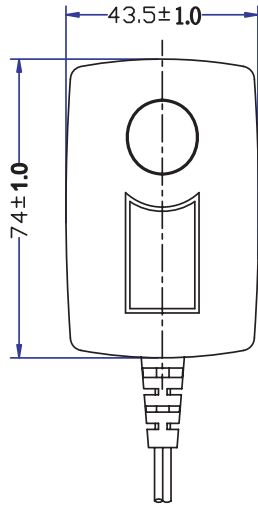



DC Cord

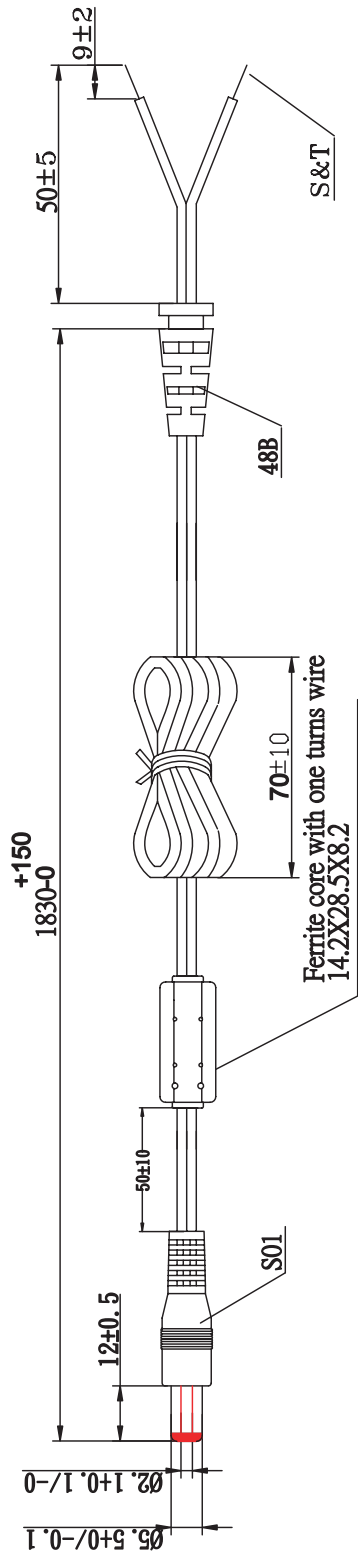

#20AWG X2C UL2468 HAVE ON WORD WIRE IN OUTER, NO WORD WIRE IN INNER

OD: Ø1.9*3.8 — — — — — +

VIBRATION TEST	a. ±60°
	b. WEIGHT 200g
	c. 40 ROUND/MINUTE
	d. OVER 1000 COUNT MIN



CUI INC

Part No: EMS180100-P5P-SZ

Description: switching power supply
w/ interchangeable input blades

Date: 5/29/2007

Unit: mm

Page No: 5 of 6

Individual Packaging

Tolerance: ± 1

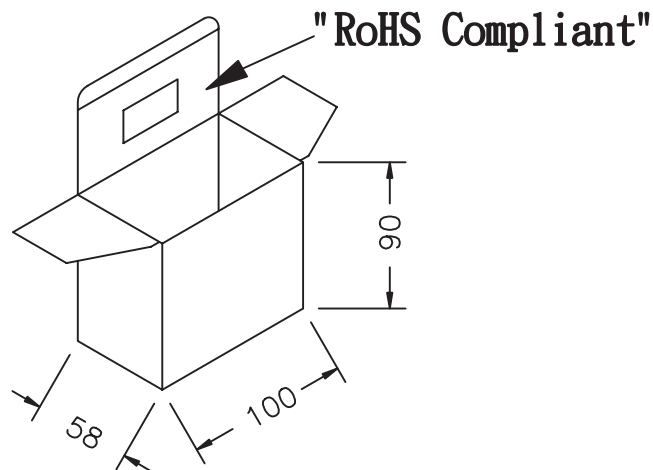
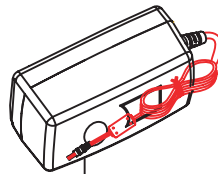
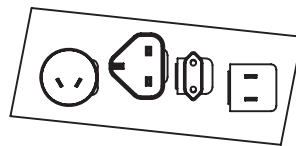
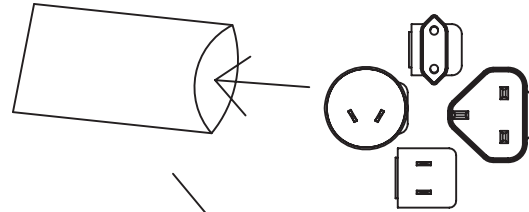



CUI INC

Part No: EMS180100-P5P-SZ

Description: switching power supply
w/ interchangeable input blades

Date: 5/29/2007

Unit: mm

Page No: 6 of 6

Packaging

Tolerance: +7/-0

CARTON SIZE: 485X428X210mm

Q'TY: 60pcs(20x3x1)

"RoHS Compliant"

